

Data Sheet



Article number: 03445260

Description: Fluro Heavy Duty Spherical Plain Bearing GE 260 EW-2RS
Hole \varnothing 260

Note: 260

Measures

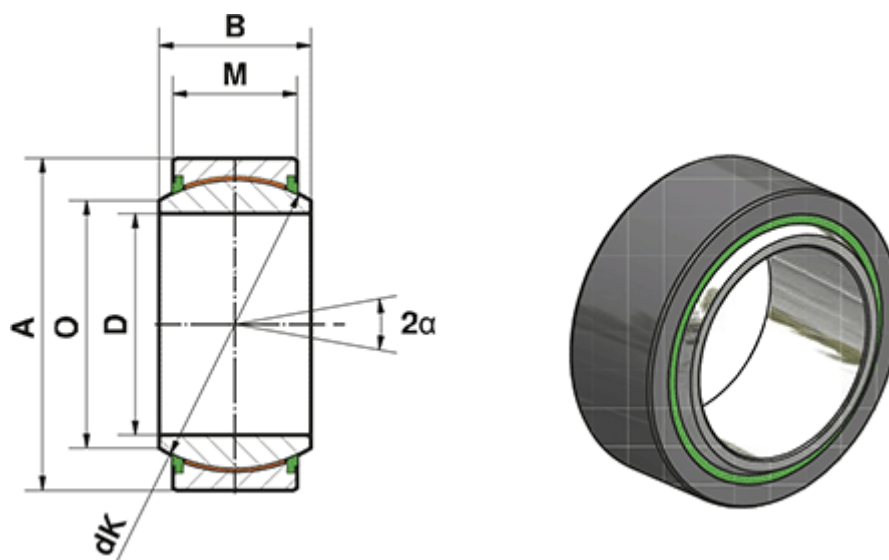

A	= 270	Static load C0 (kN) = 14250
a (degrees)	= 7	Weight (g) = 50800
B	= 150	
D	= 260	
dk	= 325	
Dynamic load C (kN)	= 8550	
M	= 110	
O	= 288.3	